

Description	1
Safety	2
Operator protection	2
Preparing for spraying.....	3
Mixing, filling and calibration	4
Before spraying	10
To start spraying.....	12
To stop spraying – at the end of each spray pass/row.....	13
To stop spraying – at the end of the spraying operation	14
After spraying.....	14
Storage and maintenance.....	15
Diagram – ULVA+/Refilling system/ <i>Micropak</i> backpack	16
Parts List – ULVA+/Refilling system/ <i>Micropak</i> backpack	17
Troubleshooting	18

DESCRIPTION

The ULVA+ is a simple robust hand-held spinning disc Controlled Droplet Application (CDA) sprayer powered by torch (D-cell/R20) batteries, with one set of good quality batteries giving up to twenty hours spraying time. It is designed primarily for the foliar application of insecticides and fungicides – both water-based mixtures (e.g. ECs, WPs) at 10 to 20 litres/hectare total spray volume and involatile Ultra-Low Volume (ULV) formulations at 1 to 3 litres/hectare. An electric motor spins the atomiser disc to produce uniform spray droplet size ranges (the actual size of droplets produced depends on the atomiser disc speed which is determined by the number of batteries fitted). Liquid is fed by gravity through colour coded feed nozzles. The ULVA+ can apply insecticides and fungicides to various row crops e.g. cotton, groundnuts, rice, vegetables, etc., (and it can also be used for the control of migrant pests with ULV formulations e.g. locusts, grasshoppers and armyworm). The sprayer produces relatively small spray droplets which are distributed and deposited by wind and gravity, allowing several rows/metres to be treated during each spray

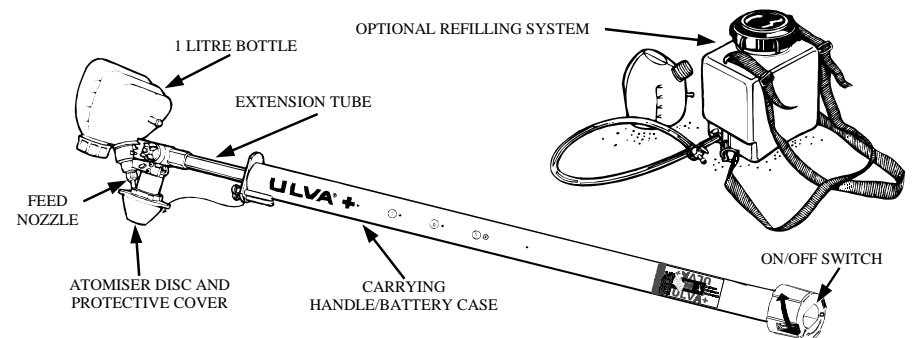

Specially designed *Micropak* backpacks can be supplied for use with the ULVA+, with a refilling system to refill the one litre spray bottle fitted to the spray head. Only use ULV formulations with a backpack if appropriate chemically resistant tubing is available (e.g. Micron *Micropaks* fitted with EVA tubing).

SAFETY

Using agrochemicals is a hazardous process. Operators should comply with all relevant legislation and/or regulations governing the use of agrochemicals and should use appropriate personal protective equipment (see 'OPERATOR PROTECTION').

The ULVA+ can be used with most traditional water-based insecticide and fungicide products, as well as specific ULV formulations (only available in some countries) which can reduce risks in mixing and filling.

Always read the product label carefully to discover:-

- ◆ approved applications
- ◆ maximum dose rates
- ◆ maximum number of treatments
- ◆ operator protection required
- ◆ necessary environmental protection measures

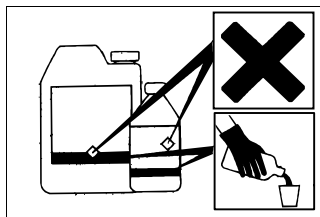

N.B. 'Dose rate' refers to the amount of chemical product applied per hectare.

Never eat, drink, or smoke when working with agrochemicals. After using agrochemicals or handling equipment wash your hands thoroughly. Keep people (especially children) and animals out of areas being sprayed.

Always store agrochemicals safely to protect people and animals, and to safeguard the environment (take special care to avoid water pollution). See 'SPRAYING' sections for guidelines on safe use of the ULVA+ in operation.

OPERATOR PROTECTION

Always wear the protective clothing items listed on the product label for mixing and filling. The **minimum** protective clothing required for **spraying** with the ULVA+ is:

- ◆ rubber gloves and boots
- ◆ Face shield, eye protection and hat
- ◆ long sleeved shirt and trousers



DECLARATION OF CONFORMITY

Name of manufacturer or supplier: Micron Sprayers Ltd.
 Full postal address: Bromyard Industrial Estate,
 BROMYARD, Herefordshire
 Country of origin: England
 Post code: HR7 4HS
 Description of Product: Battery powered, hand-held
 agricultural spraying machine.
 Name and model number of machine: ULVA+
 Place of Issue: Bromyard, England
 Name of authorised representative: G. S. Povey
 Position of authorised Representative: Joint Managing Director

The sound pressure level at the operator's ear does not exceed 70 dB(A). The weighted RMS acceleration value at the hands when using this machine does not exceed 2.5 m/s². Weight of machine (ready to spray): 2.6Kgs (7.5Kgs. With 5 litre backpack)

DO NOT USE in an explosive atmosphere.

DECLARATION:

I declare that as the authorised Representative, the above information in relation to the supply/manufacture of this product is in conformity with the requirements of the Machinery Directive 89/392/EEC as amended by 91/368/EEC, 93/44/EEC, 93/68/EEC and 98/37/EC and complies with the relevant essential health and safety requirements.

Signature of authorised Representative:

TROUBLESHOOTING

- A) Atomiser disc spins but does not spray or sprays irregularly. Check:
- The feed nozzle. If the feed nozzle is incorrectly fitted refit it properly, if it is blocked remove and soak in soapy water. **Never** blow through the feed nozzle with your mouth.
 - The atomiser disc is clean and undamaged. Clean or replace.
 - The flow valve and refilling system for blockages (if using a backpack). Rinse through with soapy water (or kerosene if using ULV products).
 - The red bottle cap is screwed on correctly and undamaged (if using the one litre twin neck bottle) and that the seal inside the cap is in place and undamaged.
- B) Atomiser disc fails to spin or spins unevenly/intermittently. Check:
- The switch. If the brass screw looks worn turn it to a new position (with unworn thread) using a screwdriver or coin.
 - That the batteries are fitted correctly.
 - The condition of the batteries (see below). Replace if necessary.
 - That the extension tube is clean and moves freely.
 - That the electrical terminals and contact points are clean and that electrical wires are not broken or corroded. Check that the terminal connecting springs on the motor are in place if the spray head has previously been disassembled.
 - If the atomiser disc is rubbing on the motor base plate or the motor shaft is bent, Replace the disc or motor if necessary (see ‘STORAGE AND MAINTENANCE’ for motor replacement).
 - The motor for corrosion or obvious signs of wear. Replace if necessary (see ‘STORAGE AND MAINTENANCE’ for motor replacement).
- C) Liquid leaks from the bottle holder on the spray head. Check:
- The red bottle cap is screwed on correctly and undamaged (if using the one litre twin neck bottle) and that the seal inside the cap is in place and undamaged.
 - The flow valve is closed (if using a backpack and refilling system).
 - The feed nozzle. If the feed nozzle is incorrectly fitted refit it properly, if it is blocked remove and soak in soapy water (or kerosene if using ULV

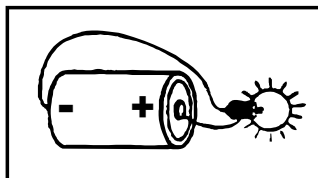

N.B. Battery condition can be checked with a torch (or a torch lightbulb and electrical wire).

PREPARING FOR SPRAYING

The sprayer is delivered in a collapsed form pre-set for use with a particular number of batteries N.B. five batteries are recommended for use with water-based products, six to eight for ULV formulations. To assemble ready for spraying:

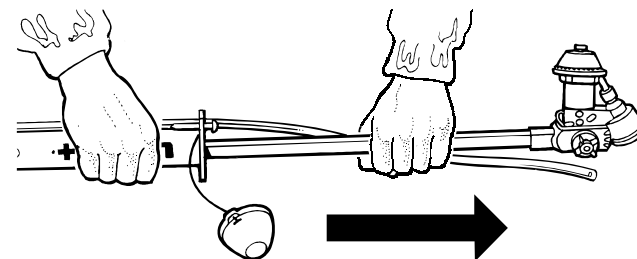

- 1) Remove the atomiser protective cover and check by hand that the atomiser disc spins freely. Extend the sprayer and screw the one litre bottle onto the spray head. **Do not** overtighten. Make sure the red cap or refilling point is in line with the extension tube. Instructions on assembling Micron *Micropak* backpacks are contained inside the tank. N.B. the feed tube from the *Micropak* must be securely connected to the flow valve which should be fitted into the valve retaining clamp on the battery case and the hose connections secured with the clips supplied. The tubing on the sprayer should be clipped into the large hole on the battery case end cap and attached to the flow valve.

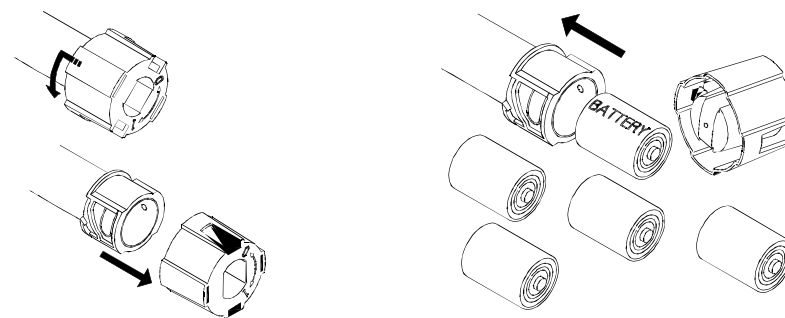

- 2) Remove the switch end piece as shown on the label
- 3) Insert the required number of batteries (D-cell/R20) negative, i.e. flat, end first

N.B. Battery condition should always be checked before use, either in a torch or using a torch lightbulb and electric wire – see ‘TROUBLESHOOTING’. Before spraying for the first time with the ULVA+, sprayer operation should be checked using **only** water (see ‘BEFORE SPRAYING’).

MIXING, FILLING AND CALIBRATION

Mixing and filling is generally the most hazardous process in the spraying operation. **Always** follow the label instructions. **Always** use a filter (fitted in the Micron *Micropak* backpacks) and use a funnel if directly filling the spray bottle. **Only** mix enough spray for the area to be treated if using water-based mixtures to avoid the need for disposal of unused spray mix.

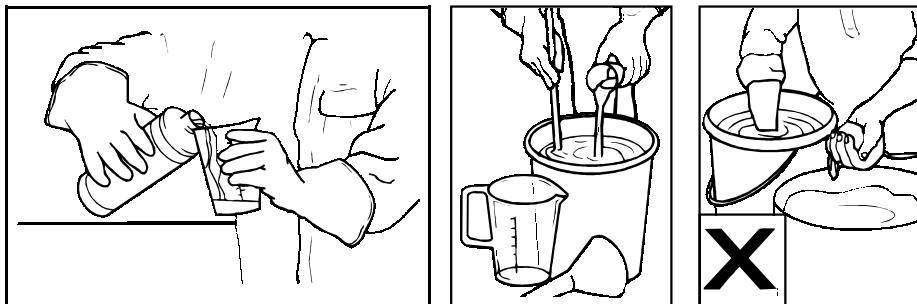

Always wear gloves when handling agrochemicals and equipment.

Always use the correct equipment when mixing and measuring.

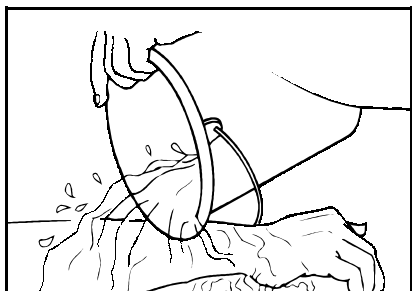

Always wash off any skin contamination

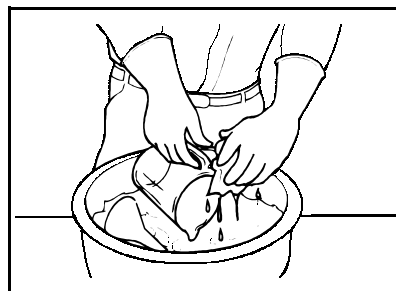

Always clean all equipment after use.

ULV FORMULATIONS

ULV formulations are pre-mixed, i.e. ready to spray, and should have full instructions for use on the label. These products can be poured directly into the spray bottle using a funnel, if using the one litre twin neck bottle, or directly into the backpack.

ULVA+ PARTS LIST

DESCRIPTION	PART NO.	DESCRIPTION	PART NO.
BOTTLE CAP – BLACK	3216	FEED NOZZLE, GREY	5409
AIR VENT TUBE – 0.20M	3512/20	LABEL, ULVA+	5410
WIRE, 1.00MM, BLACK – 0.94M	4134/94	BUNG	5415
WIRE, 1.00MM, RED – 0.98M	4368/98	RETAINING STRAP	5451
SPRING HOLDING PIN	4447	TERMINAL RING	5575
SPRING, 9/32"	4457	NUT, M5, WING	6019
LABEL, BATTERY ON/OFF	4460	WASHER, M5 X 25 OD X 1.5 THICK	6020
BOTTLE CAP – BLACK	4489	SCREW, M5 X 30, HEX. SET	6021
SCREW, NO. 6 X 3/8" S/T	4646	SWITCH PLUG	6042
BOTTLE, 1 LITRE (TWIN NECK)	5265	SWITCH SLEEVE	6043
MOTOR, 12 VOLT, ULVA+	5320	SWITCH CONNECTOR	6044
CORK WASHER	5353		
SPRING, BATTERY CASE	5363	REFILLING SYSTEM/MICROPAK BACKPACK	
BOTTLE HOLDER	5365	TUBE, 6MM ID X 9MM OD – 1.00M, PVC	4993/100
MOTOR FRONT PLATE	5366	STRAP – 1.25M	5107/125
MOTOR HOUSING	5367	BOTTLE, 1 LITRE (REFILL SYSTEM)	5290
HEAD LOCKING SLEEVE	5368	BACKPACK, 5 LITRE	5404
NUT, UNION – BLACK	5369	TUBE, 8MM ID X 12MM OD – 0.90M, PVC	5414/90
DISC FIXING SCREW	5372	CLIP, HOSE, SIZE BB	5417
ATOMISER DISC	5373	CLIP, HOSE, NO.12, WINGSCREW	5464
CENTRE CONNECTOR	5375	TAP	5776A
BATTERY CASE END CAP	5376	HOSE CONNECTOR, 6MM	5778
BATTERY CASE	5377	UNION NUT	5779
FEED NOZZLE, YELLOW	5383	VALVE CLAMP	5780
FEED NOZZLE, ORANGE	5384	SCREW, M5 X 12, POZI, PAN, PT	5956
FEED NOZZLE, RED	5385	CLIP, HOSE, WIRE 9.1MM	6028
FEED NOZZLE, BLACK	5386	CLIP, HOSE, WIRE 11.9MM	6029
FEED NOZZLE, PINK	5387		
PROTECTIVE COVER	5396	CAP AND FILTER ASSEMBLY FOR 5404	
'O' RING, BS 012, VITON	5398	CAP, BACKPACK – BLACK	5208
SCREW, NO.6 X 3/8" S/T POZI PAN/HEAD B	5399	BALL, 3/16" DIA, POLYPRPYLENE	5210
EXTENSION TUBE	5400	CORK GASKET SEAL	5346
'O' RING, BS 121, VITON	5403	AIR BLEED VALVE BODY	5448
ATOMISER WASHER	5407	FILTER (BACKPACK)	5449

MICRON ULVA+

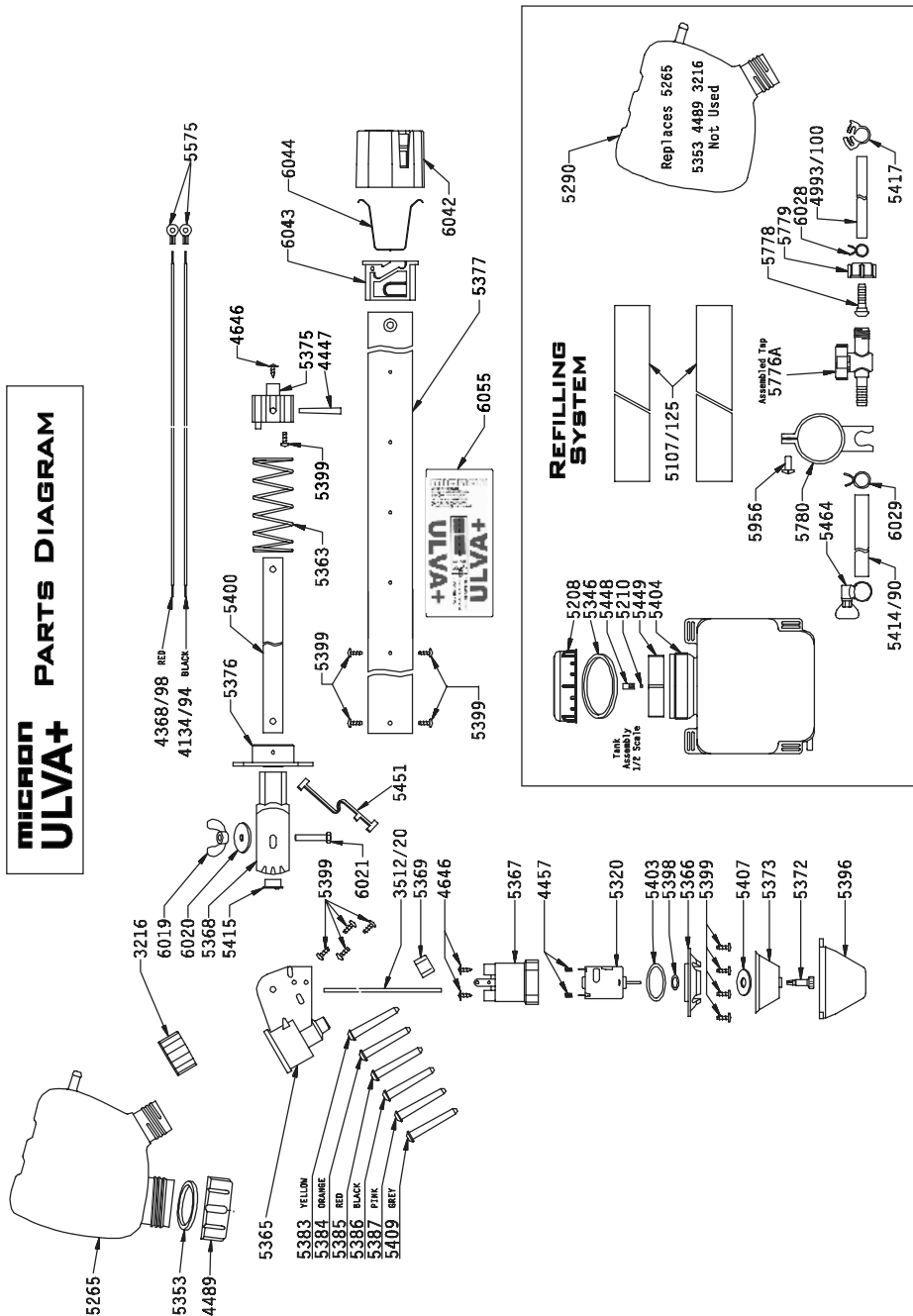

WATER-BASED PRODUCTS

Traditional water-based insecticides and fungicides are usually applied with the ULVA+ at 10 to 20 litres total spray volume per hectare. Most insecticides can be used at 10 litres/hectare but fungicides may require around 20 litres/hectare. For example, if the label recommends applying a minimum of 1 litre of insecticide product made up to 100 litres of water per hectare with a knapsack sprayer, use 1 litre of product made up to 10 litres for application with the ULVA+, i.e. a spray mix concentration of 10%.

Do not use product concentrations greater than the maximum recommended on the label (unless specific training or recommendations have been given) if the label:

- a) specifically prohibits use of 'Reduced Volumes' i.e. increased concentrations;
- b) has a statutory requirement for use of personal protective equipment when using the diluted product at high volumes (N.B. this will appear in the statutory box on the label);
or
- c) carries one of the following hazard ratings: 'very toxic', 'toxic' or 'corrosive' or carries the warning 'risk of serious damage to the eyes'.

Micron do not generally recommend using spray mixes of more than ten times the maximum concentration recommended for high volume application with knapsack sprayers. At high concentrations some products can be phytotoxic to crops thus, if in doubt, first spray a small test area. The safest product and lowest dose rate appropriate for the treatment should be used at all times.

To prepare the spray mix with water-based products select the dose rate of product to be applied per hectare and mix in a suitable container e.g. a Micron *Micropak*

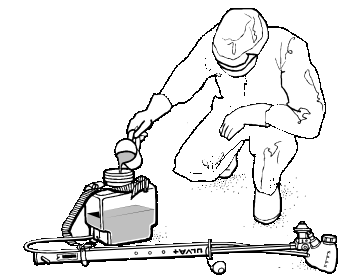

Measure out the exact amount of product.

Half fill the tank with clean water. Check for leaks. Add the measured product.

Never use leaking equipment. Take care to avoid spillage when filling or lifting the tank.



Finish filling the tank with clean water.



Replace the tank lid. Wipe the tank with a dry cloth

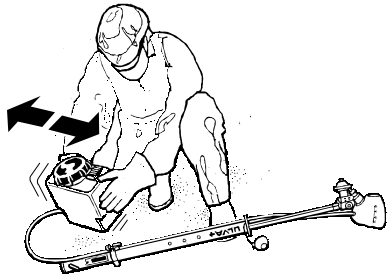

Mix well by gently shaking the tank.

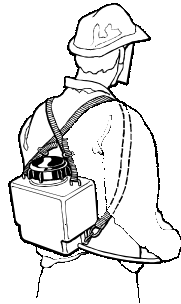

Place the tank on the operator's back.



Transfer the spray mix to the one litre bottle on the spray head (by placing the base of the bottle on the ground and opening the flow valve).

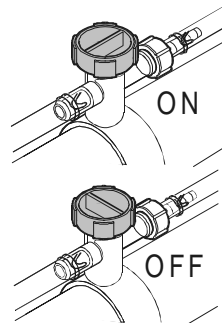

When the bottle is filled to the 1 litre mark stop filling. The flow valve **must** then be turned off.

STORAGE AND MAINTENANCE

Before storing the ULVA+ for long periods remove the motor and dry it to avoid corrosion. To disassemble the spray head remove the atomiser disc and feed nozzle, unscrew the four screws in the motor housing and then detach the front part of the motor housing. Remove the motor by its shaft and dry, e.g. placing it in the sun for a few hours. Re-assemble (with a new motor if the existing motor is corroded or worn) making sure that the 'O' ring seals (part nos. 5403 and 5398) and terminal connecting springs are correctly positioned. Make sure they polarity is correct N.B. the positive terminal has a small mark and should be connected to the red wire. Check that the small nylon air vent tube is replaced correctly within the extension tube. The sprayer can be disassembled by removing the four screws in the battery case and all electrical contacts cleaned with a wire brush or similar. If the extension tube is dirty where it passes through the battery case end cap this should be cleaned. Re-assemble and with the sprayer in the collapsed position, i.e. batteries removed, store in a dry place away from direct sunlight. Batteries should be stored in a cool dry place.

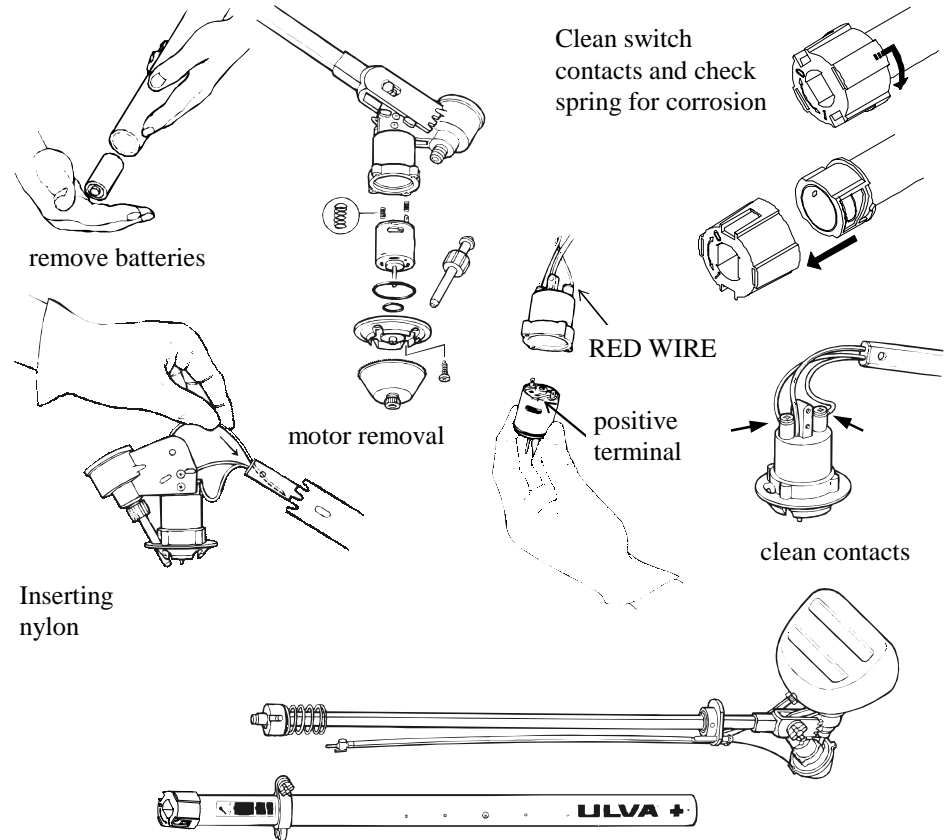

2. It is **essential** to clean the sprayer and tank thoroughly after use. **Never** immerse the spray head in water or under a tap, since this will destroy the electric motor. If using water-based mixtures a water and detergent mix should be put in the tank, swilled around, and then sprayed out onto the treated area or an area of waste ground. If using ULV formulations use kerosene (**do not** use water and detergent) for cleaning out the sprayer. The sprayer and tank (but **not** the atomiser disc) should be wiped down externally using a cloth. Periodically remove the atomiser disc and clean with a soft brush, especially if wettable powders have been used since these can build up on the atomiser disc and cause poor performance.

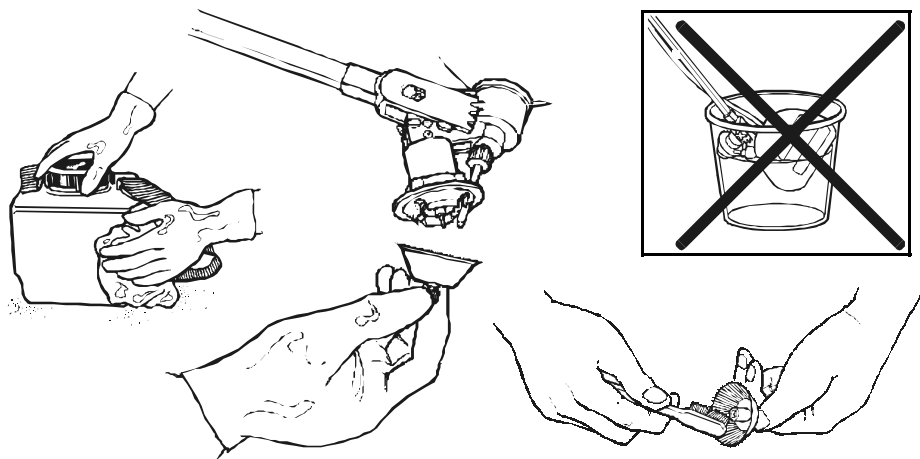

3. After working with agrochemicals, or handling spraying equipment, **always** thoroughly wash hands and exposed skin. All protective clothing should be washed and stored separately from other clothing. Contaminated gloves should be washed inside out.

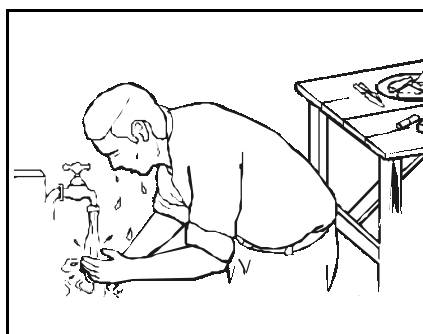

CALIBRATION

ULV FORMULATIONS

The table below indicates the relationship between spray volume, flow rate and walking speed for the ULVA+ as per the following formula:

$$\text{Flow rate (ml/min)} = 6 \times \text{spray pass interval (m)} \times \text{total spray volume (l/ha)} \times \text{walking speed (m/s)}$$

Spray volume (l/ha)	Spray pass Interval (m)	Feed nozzle	Flow rate* (ml/min)	Walking speed (m/s)
0.8 Crop pests	5	Yellow	25	1.0
1.0 and diseases	5	Orange	34	1.1
1.0	3	Red	60	1.1
1.0 Migrant pests	5	Orange	34	1.1
1.0	10	Red	60	1.0

* Note: Assumes a standard ULV formulation viscosity of 7mm²/sec. The flow rate will differ with liquid viscosity and for more viscous formulations it may be necessary to use a larger feed nozzle.

For ULV applications spray passes of 3 to 6 meters can generally be used in crop situations (5 to 10 meters for control of migrant pests on rangeland). Spray pass intervals should be reduced as crop height increases.

Choose and fit the feed nozzle that is likely to be required. The actual flow rate should be checked holding the ULVA+ in the spraying position with the feed nozzle vertical. Remove the atomiser disc by unscrewing the disc fixing screw by hand and **then** turn over the sprayer. Wait until the liquid flow is steady and then allow the liquid to flow into a suitable container for one minute and measure the volume dispensed. If the flow rate is substantially different from that required change the feed nozzle and repeat the above procedure. If the flow rate is close to that required adjust walking speed.

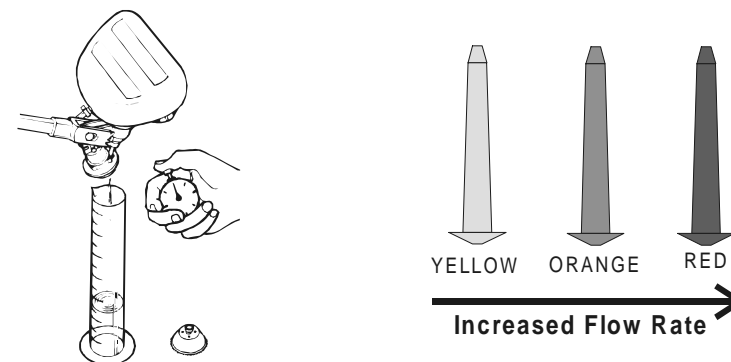

Example: Required spray volume = 1 l/ha; Spray pass interval = 5m
Flow rate measured = 40 ml/min

$$\text{Walking speed (m/s)} = \frac{\text{Flow rate (ml/min)}}{6 \times \text{spray pass interval (m)} \times \text{total spray volume (l/ha)}} = \frac{40}{6 \times 5 \times 1} = 1.33$$

i.e. 1.33 m/s or 80 metres in one minute (1.33 x 60)

Mark out a distance of 80 metres and practice walking it in one minute.

WATER BASED PRODUCTS

Examples of mixing spray – for 1 hectare:

a) insecticide:	1litre	b) fungicide:	3 litres
add water:	+9 litres	add water:	+17 litres
Total volume:	10 litres	Total volume:	20 litres
i.e. 1 part insecticide :	9 parts water	i.e. 3 part insecticide :	17 parts water

The following table indicates the relationship between spray volume, flow rate and walking speed for the ULVA+ as per the following formula:

$$\text{Flow rate (ml/min)} = 6 \times \text{spray pass interval (m)} \times \text{total spray volume (l/ha)} \times \text{walking speed (m/s)}$$

Spray volume (l/ha)	Spray pass Interval (m)	Feed nozzle	Flow rate* (ml/min)	Walking speed (m/s)
10)	1.2	Red	90	1.0
10) Crop pests	2.5	Black	150	1.0
10) and diseases	3.0	Grey	175	1.0
15)	2.0	Pink	195	1.1
20)	1.5	Grey	175	1.0

* Note: Flow rates measured with water plus surfactant. Some products when mixed in water can be more viscous and the actual flow rate through each feed nozzle may be different from that indicated. For very viscous spray mixes it may be necessary to use a larger feed nozzle.

TO STOP SPRAYING – at the end of each spray pass/row

At the end of each spray pass or row turn the sprayer over (so that the spray bottle is underneath the spray head) to stop the liquid flow, then switch off the sprayer. Move upwind to the start of the next spray pass and start spraying again. The operator should **always** keep the spray head downwind from their body.

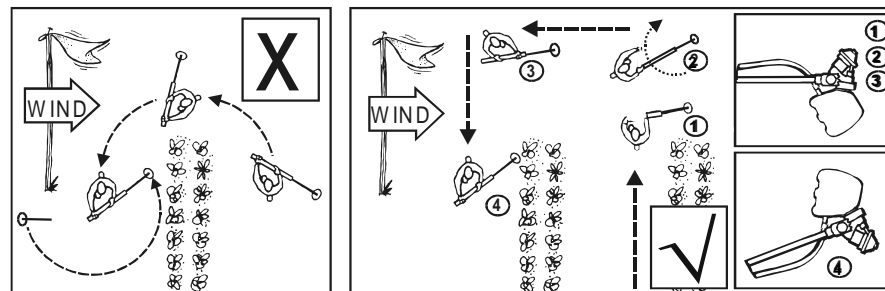

TO STOP SPRAYING – at the end of the spray operation

When spraying is finished either spray out any remaining spray mix from the bottle or drain back into the backpack by holding the spray head up (with the spray bottle underneath the spray head) and opening the flow valve. The flow valve **must** be closed once all the spray mix has been drained back into the backpack to avoid leakage. N.B. any water-based spray mixture remaining should be used within a few days but ULV formulations can be stored for some time. Make sure that all the spray liquid is spun out from the spray head by keeping the atomiser disc running for a few seconds after the spray bottle is empty. Then switch the sprayer off.

For ease of transport the backpack can be disconnected (use the flow valve to isolate any liquid left in a backpack) and the sprayer collapsed (by removing the batteries). The atomiser protective cover should be replaced for transport (this can only be done if the sprayer is collapsed).

AFTER SPRAYING

1. Dispose of any surplus spray mix according to the product label. Store products safely, locked up and out of the reach of children.

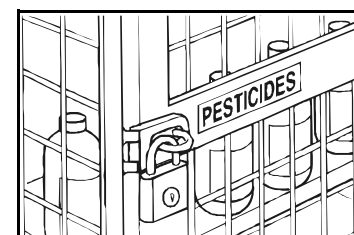

TO START SPRAYING

Hold the spray head downwind between 0.5 to 1.0 metres above the top of the crop canopy. Switch on the sprayer, check the atomiser disc starts spinning (**never** touch the atomiser disc when spinning or hold the spray head too close to the operator) and **then** turn over the sprayer. Start walking immediately.

Failure to observe wind direction and speed is the main cause of operator contamination during spraying. A flag should be placed in position where the operator can see it while spraying. Should the wind drop below 1 m/s or exceed 4 m/s or change direction **stop spraying immediately**, and either wait for the wind to become re-established or re-plan the spray operation (making sure the operator does not walk through any part of the field that has already been sprayed).

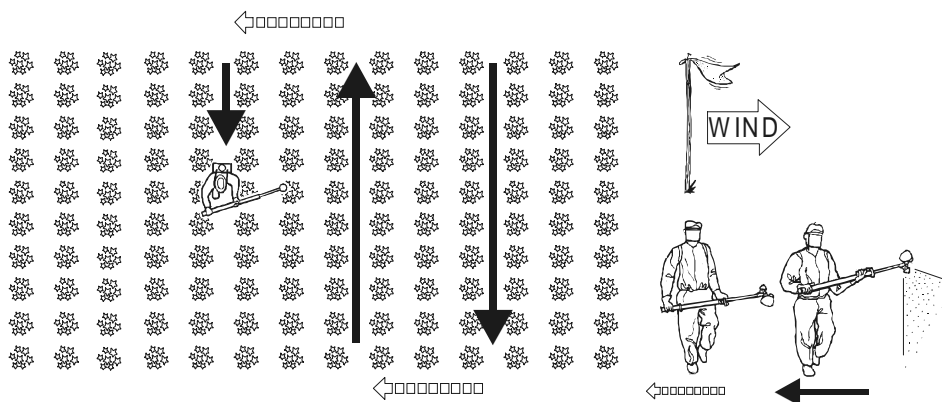

It is best to hold the ULVA+ slightly to the rear so that the operator always walks away from the spray and does not contact sprayed foliage. When using a backpack the bottle can be filled when needed by following the bottle filling procedure outlined earlier (see 'MIXING AND FILLING') N.B. The flow valve **must** be turned off before starting to spray again. When all the spray mix has been used mark the position where spraying stopped and restart spraying from this point. **Do not** walk through any part of the field that has already been sprayed when leaving the field to refill the bottle or backpack.

N.B. **Do not** exceed 3 metre spray pass intervals when using water-based spray mixtures (with the sprayer set at five batteries) since the larger spray droplet sizes being used could then result in poor spray coverage and product efficacy. Spray pass intervals should be reduced as crop height increases.

Choose and fit the feed nozzle that is likely to be required. The actual flow rate should be checked holding the ULVA+ in the spraying position with the feed nozzle vertical. Remove the atomiser disc by unscrewing the disc fixing screw by hand and **then** turn over the sprayer. Wait until the liquid flow is steady and then allow the liquid to flow into a suitable container for one minute and measure the volume dispensed. If the flow rate is substantially different from that required change the feed nozzle and repeat the above procedure. If the flow rate is close to that required adjust walking speed.

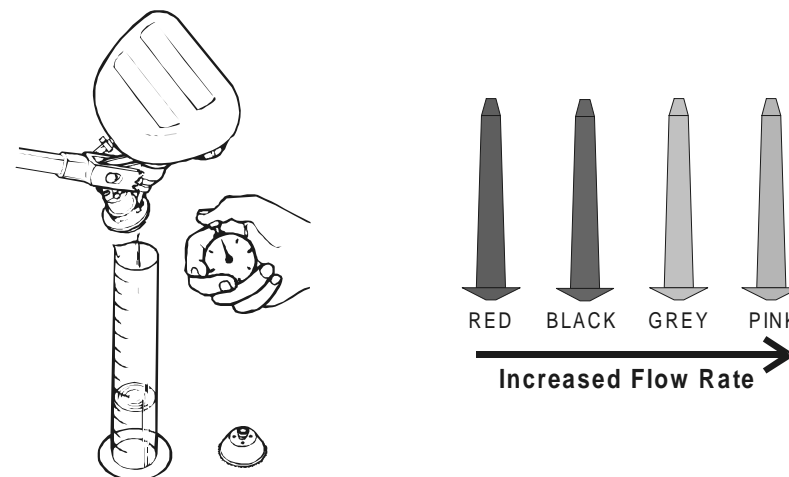

Example: Required spray volume = 10 l/ha; Spray pass interval = 3m
Flow rate measured = 150 ml/min

$$\text{Walking speed (m/s)} = \frac{\text{Flow rate (ml/min)}}{6 \times \text{spray pass interval (m)} \times \text{total spray volume (l/ha)}} = \frac{150}{6 \times 3 \times 1} = 0.83$$

i.e. 0.83 m/s or 50 metres in one minute (0.83 x 60)
Mark out a distance of 50 metres and practice walking it in one minute.

BEFORE SPRAYING

Since wind is used to distribute and deposit the spray the ULVA+ must **always** be held downwind of the operator. **Never** spray without a crosswind of at least 1 m/s (3.6 km/hr) since good results depend on overlapping spray deposits from successive spray passes i.e. an incremental spraying technique.

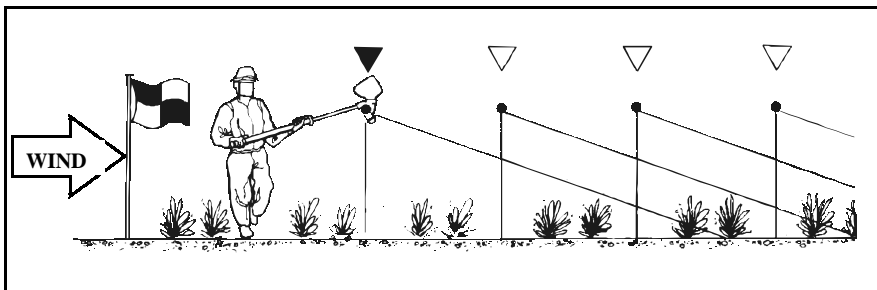

It is therefore **vital** to check the wind speed and direction before spraying. The diagrams below show acceptable wind direction and how the spray route should be planned:

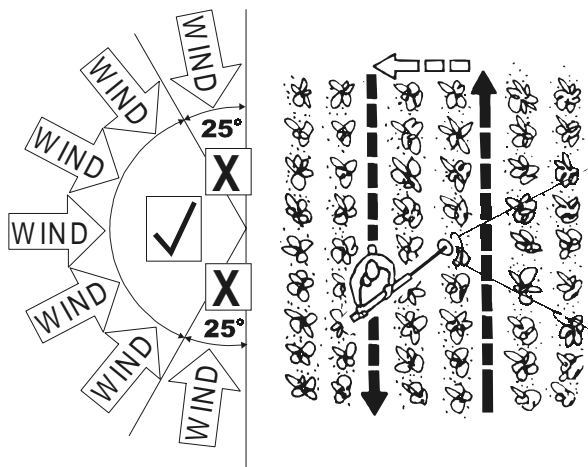

Best results will be obtained in a consistent crosswind of between 1 and 4 m/s. **Never** spray when there is no wind, or wind direction or speed is changeable, since the operator then risks being contaminated by the spray. **Always** hold the spray head at least one metre away from any part of the body to avoid the risk of direct contamination by the spray. **Never** touch the atomiser disc when it is spinning.

Check that the correct number of batteries is being used for the intended application – five for water-based products to be applied at 10 to 20 litres/hectare, six to eight for ULV formulations to be applied at 1 to 3 litres/hectare. The number of batteries can be altered by removing both battery adjustment screws on the battery case, pushing the extension tube into the battery case as far as it will go and replacing both battery adjustment screws at the desired setting. Atomiser disc speed can be checked using a tachometer – and should be 4,000 to 6,000 rpm for water-based treatments and 7,500 to 10,000rpm for ULV treatments. The operating position of the ULVA+ should be so that the feed nozzle is as close to vertical as possible. The spray head can be adjusted to accomplish this by using the head locking sleeve.

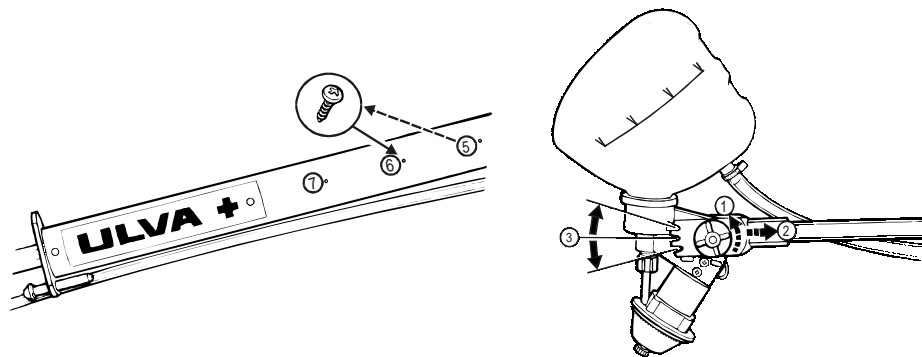

Before spraying for the first time use water **only** to check the operation of the sprayer. Put some clean water in the bottle and add a small amount of detergent. Check for leaks. Switch on the sprayer with the bottle below the spray head and **then** turn the sprayer over so that the bottle is above the spray head (spray liquid will then flow through the feed nozzle onto the atomiser disc). This is the spraying position, and spray will immediately be emitted. Start walking as soon as the sprayer has been turned over. Practice using the sprayer by walking along a few metres and then stopping spraying (see 'TO STOP SPRAYING').

