

DECLARATION OF CONFORMITY

Name of manufacturer or supplier: Micron Sprayers Ltd.

Full postal address: Bromyard Industrial Estate,
BROMYARD, Herefordshire

Country of origin: England

Post code: HR7 4HS

Description of Product: Battery powered, hand-held
agricultural spraying
machine.

Name and model number of machine: MICROFIT POWERPACK PRO
WITH HERBAFLEX LANCE

Place of Issue: Bromyard, England

Name of authorised representative: G. S. Povey

Position of authorised Representative: Joint Managing Director

DECLARATION:

I declare that as the authorised Representative, the above information in relation to the supply/manufacture of this product is in conformity with the requirements of the Machinery Directive 89/392/EEC as amended by 91/368/EEC, 93/44/EEC and 98/37/EC and complies with the relevant essential health and safety requirements.

Signature of authorised Representative:



Tuesday,

CONTENTS

	Page		Page
Description	1	Spraying	8
Safety	2	After spraying	9
Operator protection	2	Troubleshooting	11
Preparing for spraying.....	3	Parts diagram (handle).....	12
Mixing and filling	4	Parts list (handle).....	13
Spray mix calculation.....	5	Parts diagram (Herbaflex lance)	14
Calibration.....	6	Parts list (Herbaflex lance)	15

DESCRIPTION

The Microfit Powerpack Pro System is a lightweight hand held Controlled Droplet Application (CDA) sprayer with interchangeable lances, designed to apply herbicides in controlled droplet sizes of between 200 and 300 microns (about 4 times the diameter of a human hair).

The standard unit consists of a Powerpack Pro handle and a Herbaflex spray lance which allows application of narrow bands of herbicide in the range of between 10 cm (4") and 45 cm (18"). An electronic disc braking system gives immediate shut off of spray liquid and allows the sprayer to be used for spot treatments when fitted with the Herbaflex lance. Other spray lances available as optional extras include the Herbi which gives a fixed swath of around 1.2m (4 ft) and the Herbi Twin which gives up to 2.4m (8 ft).

The unit is gravity fed with flow rate being determined by the choice of colour coded feed nozzle. The sprayer is powered by 4 torch batteries (D cell/R200) which give approximately 15-20 hours spraying. The weight of the sprayer ready to use (excluding spray tank) is 1.56 kg.

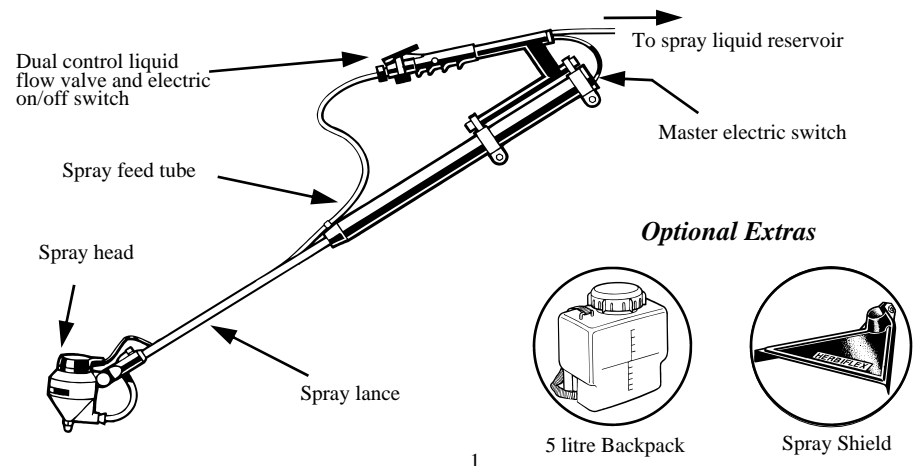

SAFETY

Using agrochemicals is a hazardous process. Operators should comply with all relevant legislation and/or regulations governing the use of agrochemicals and **must** use appropriate personal protective equipment (see 'OPERATOR PROTECTION'). **Never** use the Powerpack Pro in potentially explosive atmospheres or spray flammable liquid through it.

Always read the product label carefully to discover:-

- ◆ approved applications
- ◆ maximum dose rates
- ◆ maximum number of treatments
- ◆ operator protection required
- ◆ necessary environmental protection measures

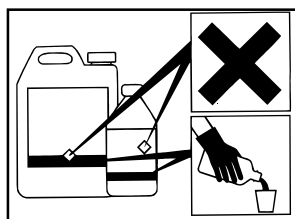

N.B. 'Dose rate' refers to the amount of chemical product applied per hectare.

Never eat, drink, or smoke when working with agrochemicals. After using agrochemicals or handling equipment wash your hands thoroughly. Keep people (especially children) and animals out of areas being sprayed.

Always store agrochemicals safely to protect people and animals, and to safeguard the environment (take special care to avoid water pollution). See 'SPRAYING' sections for guidelines on safe use of the Powerpack Pro in operation.

OPERATOR PROTECTION

Always wear the protective clothing items listed on the product label for mixing and filling. The **minimum** protective clothing recommended for **spraying** with the Powerpack Pro is:

- ◆ long sleeved shirt
- ◆ rubber gloves and boots
- ◆ long trousers
- ◆ face shield

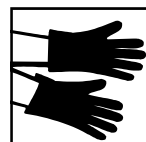
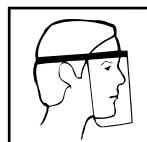

PARTS LIST – HERBAFLEX LANCE

PART NO.	DESCRIPTION	QTY.
4896A	ATOMISER CONE HOUSING, A90 (C/W 2 X 5027)	1
4908A	FEED NOZZLE, WHITE + 'O' RING (5151)	1
4910A	ATOMISER BOTTOM CONE ASSEMBLY	1
4930A	FEED NOZZLE, BLUE + 'O' RING (5151)	1
5049A	FEED NOZZLE, BROWN + 'O' RING (5151)	1
5076A	ATOMISER DISC ASSEMBLY	1
5486B	MOTOR ASSEMBLY	1
4309/96	TUBE, 5MM I.D. X 8MM O.D., PVC - 0.96M	1
3205/62	WIRE, 0.5 MM2, BLACK - 0.62M	1
3280/62	WIRE, 0.5 MM2, RED - 0.62M	1
5105/42	TUBE, 16.00 MM O.D, 16SWG, ALUMINIUM - 0.42M	1
4941/15	CABLE SLEEVE, 6MM O.D., PVC - 0.15M	1
3472	SCREW, NO. 6 X 1/4", S/T (AB)	1
4647	SCREW, NO. 6 X 1/2", S/T, CSK (B)	1
4747	CLIP, P	2
4897	MOTOR HOUSING	1
4898	TUBE/HANDLE CONNECTOR	1
4900	MOTOR COVER	1
4901	EXTENSION TUBE PIECE, HEX	1
4907	WING NUT	1
4911	DEFLECTOR	1
4915	SCREW, M5 X 16	1
4916	MOTOR TERMINAL COVER	1
4921	NUT, M5, DOME, NYLON	1
4939	SCREW, NO. 4 X 1/2", S/T	4
4943	WASHER, 5MM, FLAT, NYLON	2
4960	WASHER, 4BA, BRASS	2
5085	ELECTRICAL SOCKET	1
5086	PUSH BUTTON	1
5088	VALVE/HOSE CONNECTOR	1
5101	SPRING	1
5102	UNION NUT	1
5103	CONNECTOR PIN	2
5127	SCREW NO. 4 X 1/4", PANHEAD, S/T (B)	1
5132	LABEL, HERBAFLEX	1
5151	O' RING	1
5316	O' RING	1
5317	O' RING	1
5399	SCREW, NO. 6 X 3/8", S/T, PANHEAD,	2
5487	MOTOR SPACER	1
ACCESSORIES (not shown)		
5137A	MEASURING CUP, 50 ML + CAP	1
5264	CALCULATOR, HERBAFLEX (not shown)	1
OPTIONAL EXTRAS (not shown)		
5074A	ATOMISER CONE HOUSING, B120 (C/W 2 X 5027)	
5140A	FEED NOZZLE, YELLOW + 'O' RING (5151)	
5141A	FEED NOZZLE, ORANGE + 'O' RING (5151)	
5142A	FEED NOZZLE, RED + 'O' RING (5151)	
5171A	SPRAY SHIELD (FOR USE WITH ATOMISER CONE HOUSING A90)	

PARTS DIAGRAM – HERBAFLEX LANCE

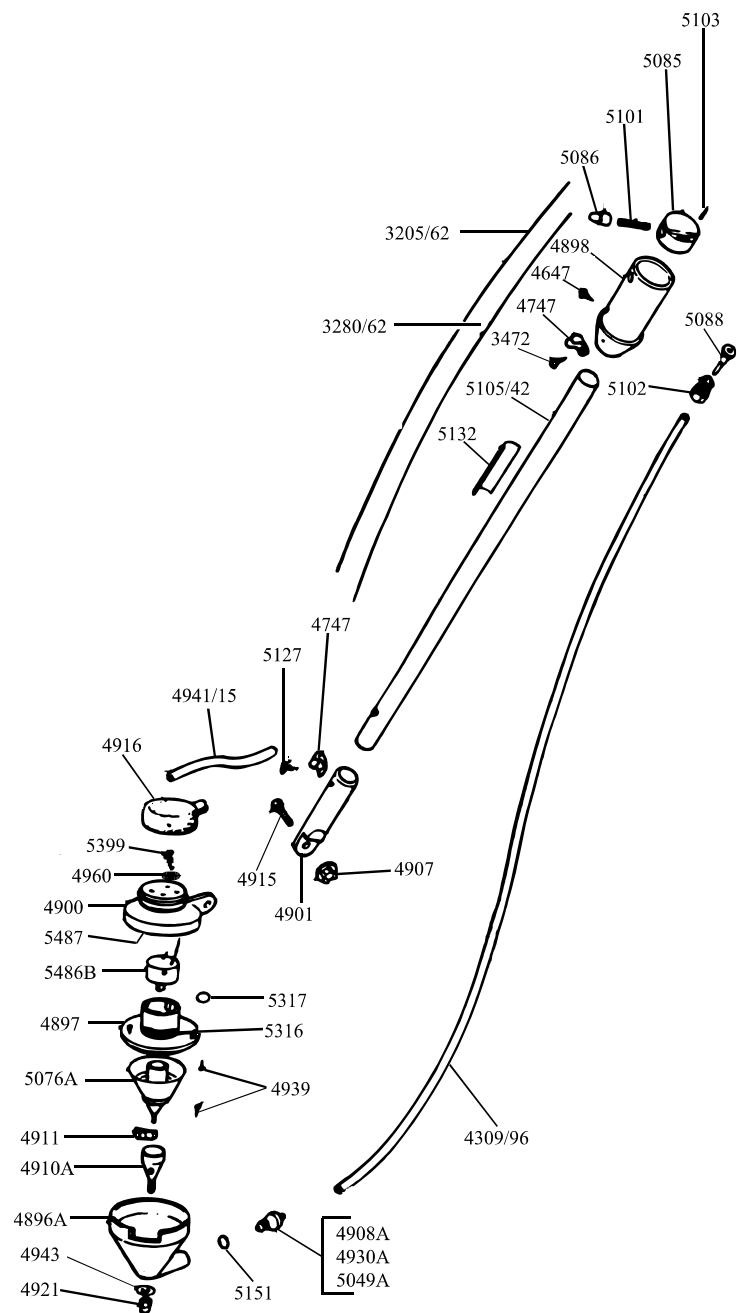

Note:

a) Acoustic information: the sound pressure level at the operator's ear does not exceed 70 dB(A).

b) Vibration: the weighted RMS acceleration value at the hands when using this machine does not exceed 2.5 m/sec².

PREPARING FOR SPRAYING

Before using the Powerpack Pro for the first time, fit four batteries (D cell/ R 20PP) into the handle. This is done by removing the master electric switch and inserting the batteries, flat end first so that the positive terminal connects to the switch. When inserting the batteries care should be taken to avoid trapping the red wire leading the master electric switch between the switch and the top battery.

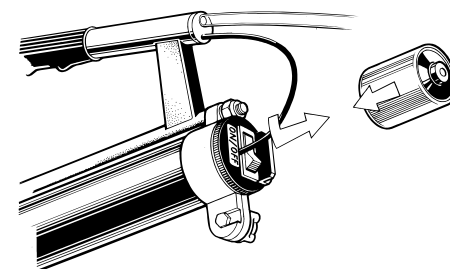

Connect the spray lance to the electrical socket on the handle ensuring that the white button locates properly. Check that the motor runs properly by first switching on the master electric switch and depressing the dual control switch briefly. It should be possible to hear the atomiser disc spinning.

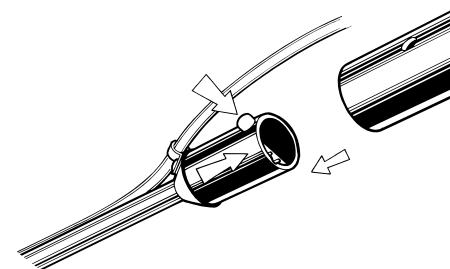

Connect the spray feed tube from the spray lance into the dual control switch on the handle.

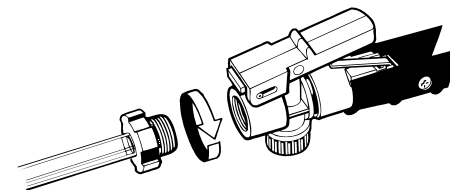

Connect the chemical delivery tube from the Powerpack Pro handle to the backpack ensuring that the dual control switch is in the closed position.

The Powerpack Pro is now ready to spray.

MIXING AND FILLING

Mixing and filling is generally the most hazardous process in the spraying operation. **Always** follow the label instructions. **Always** use a filter (fitted in the Micron *Micropak* backpacks) and use a funnel if filling a container with a small neck. Only mix enough spray for the area to be treated thereby avoiding the need for disposal of unused spray mix.

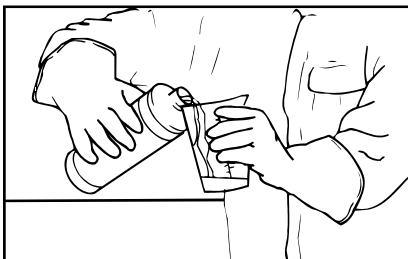

Always wear gloves when handling agrochemicals and equipment.

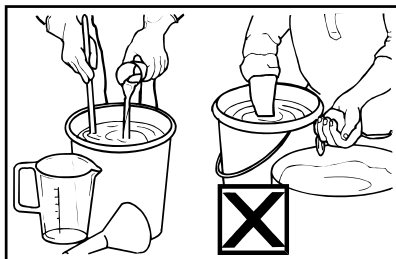

Always use the correct equipment when mixing and measuring.

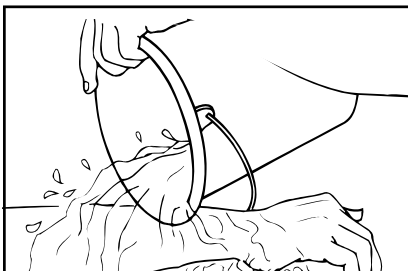

Always wash off any skin contamination.

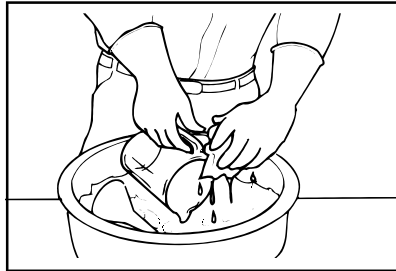

Always clean all equipment after use.

The Powerpack Pro can be used to apply either ready to use CDA herbicide formulations or standard formulations which are mixed on site.

Ready to use formulations require no mixing and will generally state on the label the total volume application rate to use. If this is the case the sprayer should be calibrated before using the first time with any new product (see 'Calibration')

In some cases the product label will make specific reference to the correct colour coded Powerpack Pro feed nozzle to be used. In this case calibration is unnecessary, though it may be advisable to check the flow rate from time to time.

PARTS LIST – HANDLE

PART NO.	DESCRIPTION	QTY
3070	SPRING, BATTERY	1
3168	WASHER, 1/4" I/D PLAIN STEEL	1
3456	SCREW, NO.6x1/4" S/T	2
3673	NUT, 2BA PLAIN STEEL	1
4318	SCREW, 2BAx1" SLOTTED PAN HD.	1
4339	SCREW, NO. 6x1/2" S/T	1
4401	SCREW, NO. 2x3/8" S/T	2
4420	NUT, 2BA NYLOC	1
4533	GRIP, 7/8" I/D, PVC	1
4646	SCREW, NO. 6x3/8" S/T	1
4749	CONNECTOR, 8MM HOSE	1
4758	SCREW, NO. 4X5/16" S/T	4
4802	SCREW, NO. 14x1/2" S/T	1
4877	WASHER, 2BA FLAT BRASS	4
4905	SWITCH COVER	1
4915	SCREW, M5x16 HEX HD S/S	2
4917	VALVE, LEVER	1
4918	SWITCH, ON/OFF	1
4939	SCREW, NO. 4x1/2" S/T	2
4954	WASHER, 1/4" I/D BRASS	1
4957	LABEL, BATTERY	1
4958	LABEL, ON/OFF	1
5027	SCREW, NO. 4x3/8" S/T	1
5050	(TAG, 1/4" FLAG)	2
5089	STRAP RETAINING CLAMP	2
5104	(CONNECTOR, SOCKET)	2
5109	SCREW, M3x6 PT	2
5112	NUT, M5 NYLOC, THIN	2
5156	INSERT, ROUND	1
5157	HANDLE	1
5158	SWITCH PROTECTOR	1
5159	NUT, M8, NYLOC	2
5160	WASHER, M8 FLAT STEEL	2
5162	SWITCH END PIECE	1
5190	CONNECTOR, MICROSWITCH	1
5191	MICROSWITCH	1
5201/40	WIRE, 0.5mmsq. x40cm long, ROUND, TWIN	1
6244	WASHER, SHIM, NYLON (AS NEEDED)	0, 1 OR 2
6048	BRAKE, ELECTRONIC ASSY.	1
6049	BATTERY CASE, 485 LONG	1
6050	ELECTRIC PLUG, BRAKE, RAD. HALF	1
6051	ELECTRIC PLUG, BRAKE, FLAT HALF	1
6052	SLEEVE, BRAKE	1
6053	CENTRE CONNECTOR	1
4993/100	TUBE 6x9x1000 long PVC	1
5130	LABEL, MICROFIT	1
5776 B	TAP	1
6028	CLIP, 9.1MM, HOSE, SELF-TIGHTENING	1

CALIBRATION

Refer to the advice given by your chemical supplier for instructions as to which colour-coded feed nozzle is most appropriate for the product in question. If no advice is given, it will be necessary to calibrate the sprayer.

To help calibrate the Herbaflex lance a calculator disc is provided with the sprayer. This is used as below:

1. Decide the total spray volume application rate to be used. A CDA rate may be indicated on the label of the product. If not, as a general guide, use 10 - 15 l/ha (total spray volume) for glyphosate and 20 l/ha (total spray volume) for other herbicides.

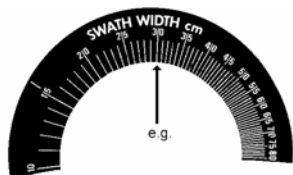

2. Decide the swath (band) width you wish to use (e.g. 30 cm) and set the angle of the head accordingly (see below).

3. On the calculator disc align the swath (band) width (in cm) with the total volume application rate (e.g. 20 l/ha) as determined in 1. above.

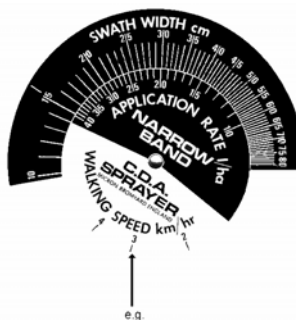

4. Having fixed the swath (band) width and application rate select the preferred walking speed (2km/hr = Slow, 3km/hr = Medium, 4 km/hr = Fast).

5. Read off the feed rate required to give the correct application rate. (e.g. 30 ml/min with 30 cm swath (band) width and walking speed of 3 km/hr to apply at a volume of 20 l/ha).

6. Fit the feed nozzle which gives the flow rate closest to that desired and adjust your walking speed accordingly. The following table is a guide to flow rates through different nozzles. Actual flow rates will vary considerably according to product and

TROUBLESHOOTING

- A) Atomiser disc spins but does not spray or sprays irregularly. Check:
- the feed nozzle. If the feed nozzle is blocked remove and soak in soapy water. **Never** blow through the nozzle with your mouth.
 - that the feed nozzle gives a flow rate within the operating range.
 - that the atomiser disc is clean and undamaged. Clean or replace.
 - the flow control valve and backpack feed tube for blockage.
- B) Atomiser disc fails to spin or spins unevenly. Check:
- that the batteries are fitted correctly.
 - the condition of the batteries. Replace if necessary.
 - that the red wire to the master electric switch is not trapped between the switch and battery preventing contact.
 - that electrical terminals and contact points are clean and that electrical wires are not broken or corroded.
 - the motor for corrosion or obvious signs of wear. Replace if necessary.
 - that the plug is in the socket.
 - that the atomiser disc and atomiser cone housing are fitted correctly.
- C) Spray liquid spills from the atomiser cone during spraying:
- angle of the spray head to the ground is too great - reduce the angle
 - flow rate too high - fit feed nozzle with lower flow rate and reduce walking speed accordingly

When refitting the atomiser disc it is important to ensure that it is correctly located in the atomiser cone housing and motor housing to avoid damage.

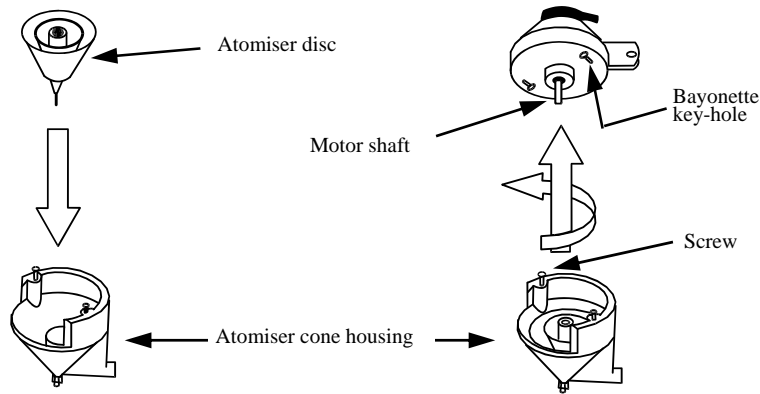

First, lower the atomiser disc into the atomiser cone housing ensuring that the disc shaft seats on the ball in the bottom of the atomiser cone assembly.



Then fit the motor housing, taking care to ensure that the motor drive shaft is correctly inserted into the slot on the top of the atomiser disc. Push the screws into the bayonet keyhole slots in the motor housing and twist to lock the assembly together.

Check that the atomiser disc is correctly fitted by shaking the spray head. If the disc can be heard rattling this means that it is fitted correctly and will spin freely.

Refit the feed nozzle, ensuring that the sealing o-ring is in place and in good condition.

Before storing the Powerpack Pro for long periods the batteries should be removed to avoid corrosion.

should be checked using the chemical mix to be applied. If using ready to use CDA formulations or marker dyes then the flow rate for these will generally be lower than for water-based spray solutions.

 Feed Nozzle 	White	Brown	Blue
	Flow rate (ml/min)		
Thin liquids (e.g. water based spray solutions)	30	45	Do not use
Thick liquids (e.g. ready to use CDA formulations)	10-15	15-25	25-35

The width of the spray band produced will depend on the angle of the spray head to the ground.

This is adjusted by partially unscrewing the wing nut (1), altering the angle of the spray head on the lance (2) and re-tightening the wing nut to lock the spray head in the new position.

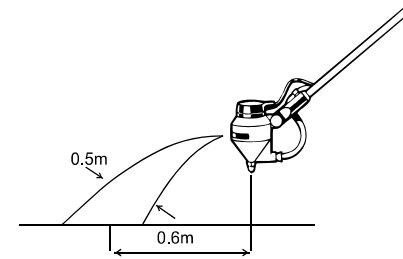
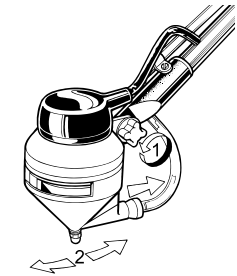

If the spray head is horizontal the spray will project ahead about 0.6 metres and spread 0.5 metres

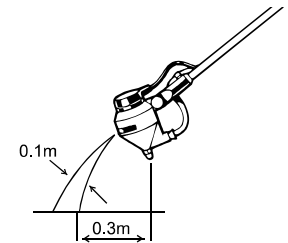

If the spray head is angled downwards the band width will be reduced.

The lance should be held so that the angle of the lance to the ground is 35°-40° and the spray head is 5-7 cm above the ground.

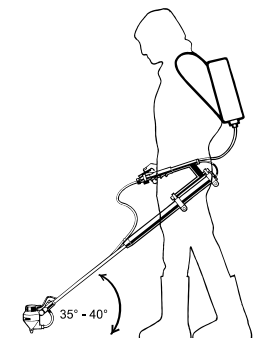

SPRAYING

A single dual control switch controls both the flow of liquid to the head and power to the spinning disc. Press the lever down (1) for treating small areas and down and forwards (2) for continuous spraying. To stop the flow, pull back the lever and release (i.e. closed position). For safety in transport, the valve can be locked in the off position by pushing the lever forward (3).

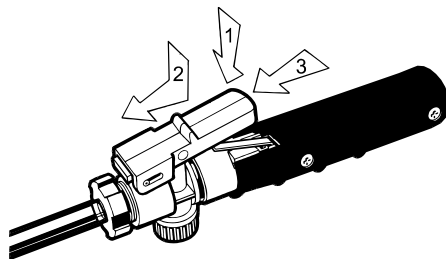

If the master electric switch is in the off position the dual control switch will regulate liquid flow only.

To start spraying, first switch on the master electric switch. Then switch on the dual control switch and, as soon as the product reaches the nozzle and spray is produced, start walking.

To stop spraying release the dual control switch by pulling back the lever. This will immediately shut off the liquid flow to the nozzle and power to the disc motor. The Powerpack Pro has an electronic braking system which stops the disc spinning immediately after the power is switched off. This makes it suitable for spot spraying and for treatment around trees etc. If stopping spraying temporarily (e.g. between trees) then there is no need to switch off the electric power at the master electric switch. Proceed to the next area to be sprayed and press down the dual control switch to begin spraying again.

NOTE As there will still be residual liquid in the bottom of the atomiser cone, care should be taken when moving between spray areas that this does not spill.

If stopping spraying for any length of time, it is advisable to also switch off power at the master electric switch and drain any liquid left in the atomiser cone housing and feed tubes back into the backpack.

To do this first ensure that the master electric switch is in the off position and raise the head of the Herbaflex lance above the level of liquid in the backpack. Then open the dual control switch and allow liquid to drain back into the backpack. When all the liquid has drained close the switch and lock in the closed position.

AFTER SPRAYING

After spraying the Powerpack Pro should be thoroughly cleaned to remove any chemical residues. This can be done either with a mild soap solution or, ideally, with a specialist cleaning fluid provided by your chemical supplier.

Connect the backpack containing cleaning fluid to the Powerpack Pro handle and spray out onto waste ground or a non-crop area until the feed tubes and the spray liquid emitted appear clean.

Wipe down the sprayer with a damp cloth and remove the batteries. **Do not** immerse the spray head in water or clean under a tap as this will result in damage to the electric motor.

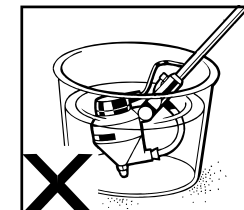

From time to time it may be necessary to clean the atomiser disc. To access the atomiser disc, the atomiser cone housing must first be removed.

To do this first remove the feed nozzle by pulling it out of the bottom of the atomiser cone housing (1). Then remove the atomiser cone housing by rotating it an eighth of a turn clockwise (as viewed from above) to unlock the bayonet keyhole fitting (2) and pull it away from the bottom of the motor housing (3). The atomiser disc can be removed from the atomiser cone housing and cleaned in soapy water, using a soft brush.

